

Stk:
Pz:
Pcs:

ART. 2193

WASSERHAHN - RUBINETTO - WATER TAP

Kunde-Cliente-Client

Datum-Data-Date

Wasserhahn mit Absperrventil,
Schlauchanschluss und Perlator
Rubinetto con valvola a leva,
attacco tubo e perlatore
Water tap with lever valve,
tube connection and perlator

ART.2093 VERLÄNGERT - PROLUNGATO - EXTENDED

a = _____ cm

b = _____ cm

c = _____ cm

d = _____ cm

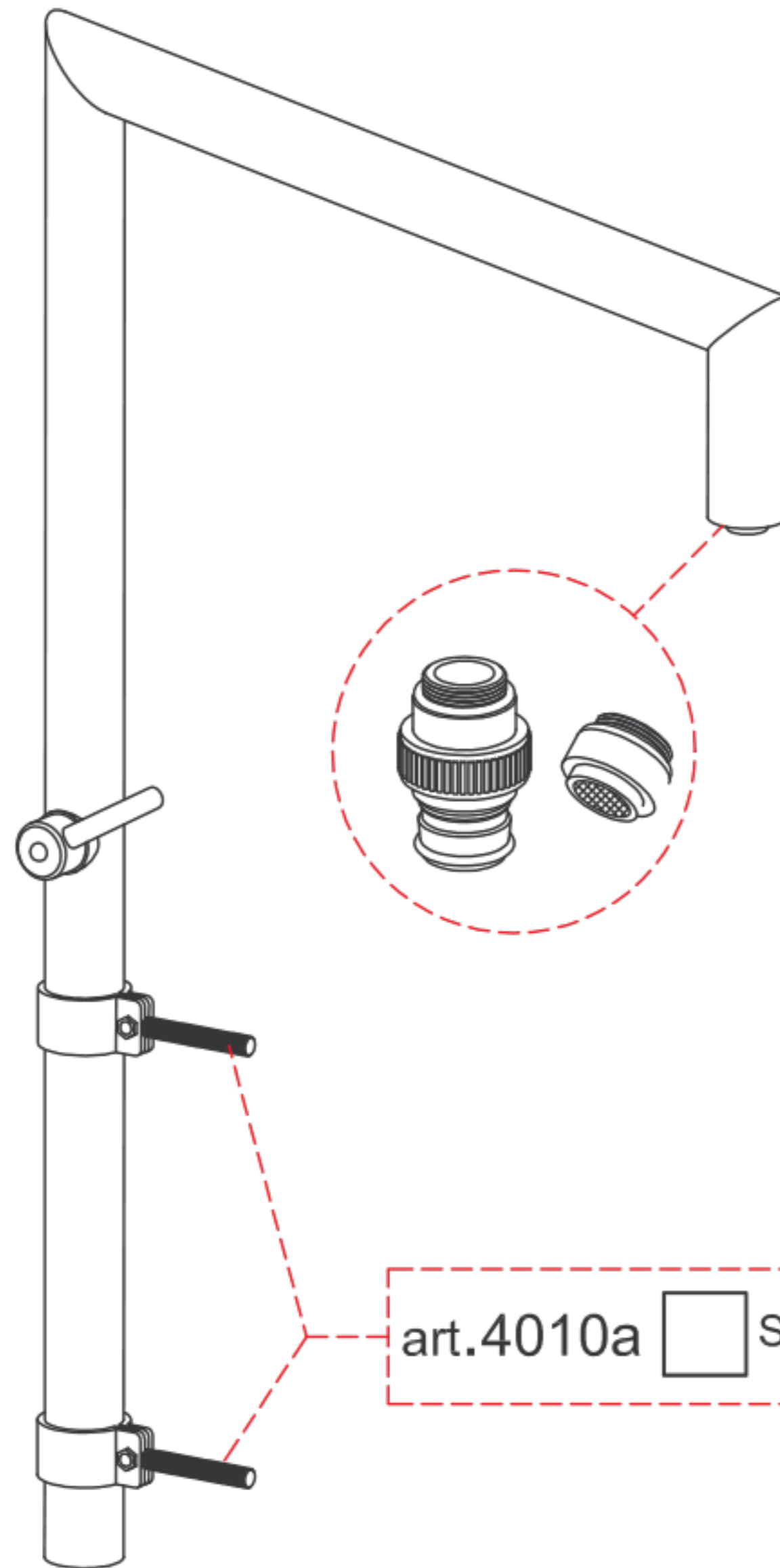
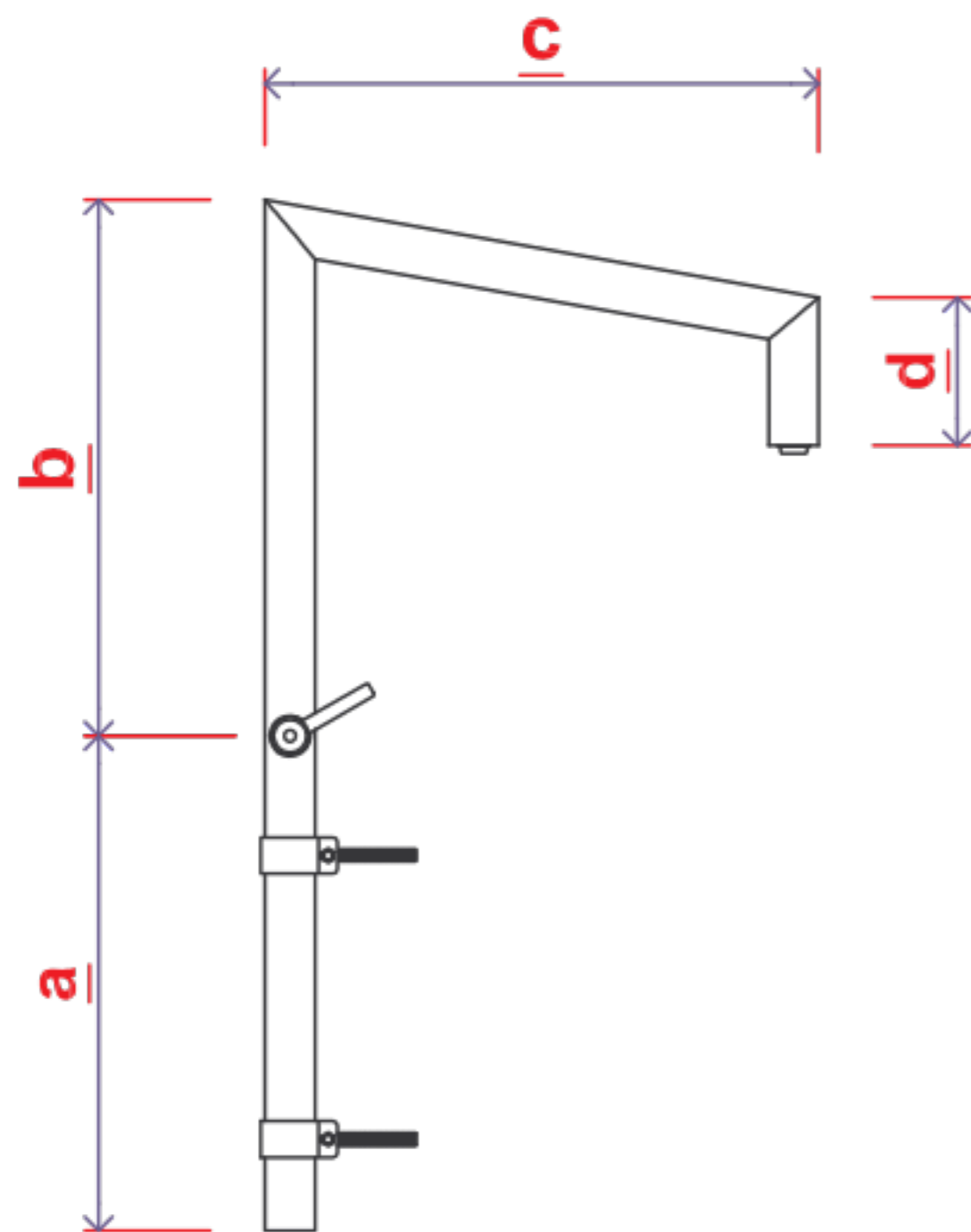

art.4010a Stk: - Pz: - Pcs:

3/4" Innengewinde - Filetto interno - Inner Thread
Ø 33 mm Rohr - Tubo - Tube

Position
Posizione
Position

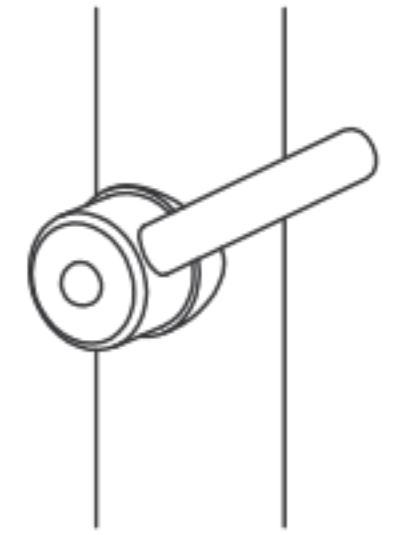

0° 90° 180° 270°

